

HTSFB-3512-20BD

SFP BIDI 1.25G 1310/1550nm(1550/1310nm) 20KM Transceiver

PRODUCT FEATURES

- Up to 1.25Gb/s data links
- FP laser transmitter for NFPB335F-SS20
DFB laser transmitter for NFPB353D-SS20
- PIN photo-detector.
- Up to 20KM on 9/125µm SMF
- Hot-pluggable SFP footprint
- BIDI SC/UPC type pluggable optical interface
- Low power dissipation
- Metal enclosure, for lower EMI
- RoHS compliant and lead-free
- Single +3.3V power supply
- Compliant with SFF-8472
- Case operating temperature
 - Commercial: 0°C to +70°C
 - Extended: -10°C to +80°C
 - Industrial: -40°C to +85°C

APPLICATIONS

- Switch to Switch Interface
- Gigabit Ethernet
- Switched Backplane Applications
- Router/Server Interface
- Other Optical Links

PRODUCT DESCRIPTION

Hirundo's HTSFB-3512-20BD Small Form Factor Pluggable (SFP) transceivers are compatible with the Small Form Factor Pluggable Multi-Sourcing Agreement (MSA). The transceiver consists of four sections: the LD driver, the limiting amplifier, the 1310nm FP laser (the 1550nm DFB laser) and the PIN photo-detector. The module data link up to 20KM in 9/125um single mode fiber.

The optical output can be disabled by a TTL logic high-level input of Tx Disable. Tx Fault is provided to indicate that degradation of the laser. Loss of signal (LOS) output is provided to indicate the loss of an input optical signal of receiver or the link status with partner.

Ordering information

Product part Number	Data Rate (Gbps)	Media	Wavelength (nm)	Transmission Distance(km)	Temperature Range(Tcase) (°C)	
HTSFB-3512-20BD	1.25	Single mode fiber	1310/1550(1550/1310)	20	0~70	commercial
HTSFB-3512-20BD	1.25	Single mode fiber	1310/1550(1550/1310)	20	-10~80	extended
HTSFB-3512-20BD	1.25	Single mode fiber	1310/1550(1550/1310)	20	-40~85	industrial

I .Pin Descriptions

Pin	Symbol	Name/Description	NOTE
1	V _{EET}	Transmitter Ground (Common with Receiver Ground)	1
2	T _{FAULT}	Transmitter Fault.	
3	T _{DIS}	Transmitter Disable. Laser output disabled on high or open.	2
4	MOD_DEF(2)	Module Definition 2. Data line for Serial ID.	3
5	MOD_DEF(1)	Module Definition 1. Clock line for Serial ID.	3
6	MOD_DEF(0)	Module Definition 0. Grounded within the module.	3
7	Rate Select	No connection required	4
8	LOS	Loss of Signal indication. Logic 0 indicates normal operation.	5
9	V _{EER}	Receiver Ground (Common with Transmitter Ground)	1
10	V _{EER}	Receiver Ground (Common with Transmitter Ground)	1
11	V _{EER}	Receiver Ground (Common with Transmitter Ground)	1
12	RD-	Receiver Inverted DATA out. AC Coupled	
13	RD+	Receiver Non-inverted DATA out. AC Coupled	
14	V _{EER}	Receiver Ground (Common with Transmitter Ground)	1
15	V _{CCR}	Receiver Power Supply	
16	V _{CCT}	Transmitter Power Supply	
17	V _{EET}	Transmitter Ground (Common with Receiver Ground)	1
18	TD+	Transmitter Non-Inverted DATA in. AC Coupled.	
19	TD-	Transmitter Inverted DATA in. AC Coupled.	
20	V _{EET}	Transmitter Ground (Common with Receiver Ground)	1

Notes:

- Circuit ground is internally isolated from chassis ground.
- Laser output disabled on T_{DIS} >2.0V or open, enabled on T_{DIS} <0.8V.
- Should be pulled up with 4.7k - 10kohms on host board to a voltage between 2.0V and 3.6V.
MOD_DEF(0) pulls line low to indicate module is plugged in.
- This is an optional input used to control the receiver bandwidth for compatibility with multiple data rates (most likely Fiber Channel 1x and 2x Rates). If implemented, the input will be internally pulled down with > 30kΩ resistor. The input states are:
 - Low (0 – 0.8V): Reduced Bandwidth
 - (>0.8, < 2.0V): Undefined
 - High (2.0 – 3.465V): Full Bandwidth
 - Open: Reduced Bandwidth
- LOS is open collector output. Should be pulled up with 4.7k - 10kohms on host board to a voltage between 2.0V and 3.6V. Logic 0 indicates normal operation; logic 1 indicates loss of signal.

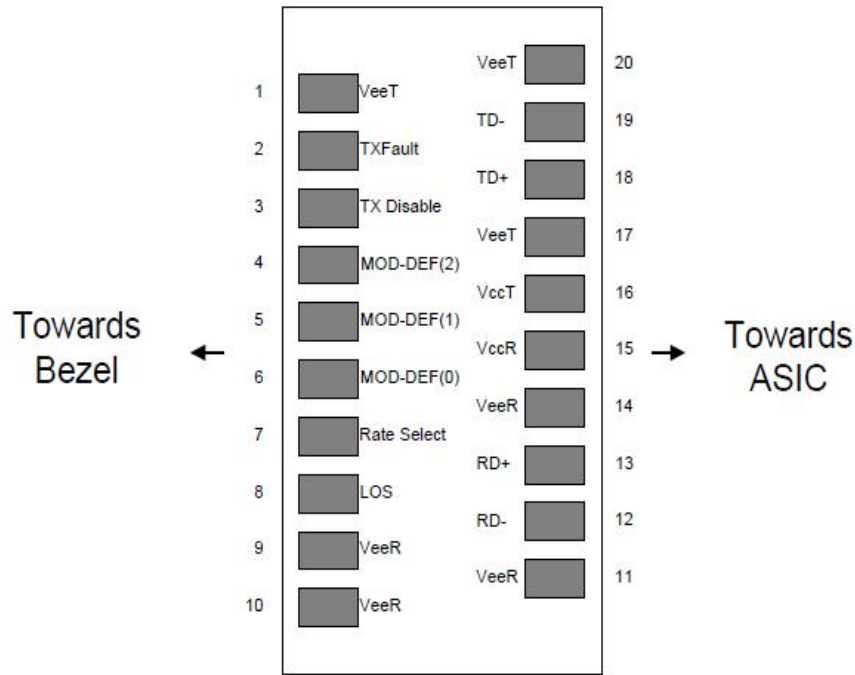

Figure 2: Pin out of Connector Block on Host Board

II. Absolute Maximum Ratings

Parameter	Symbol	Min.	Typ.	Max.	Unit	Note
Storage Temperature	Ts	-40		85	°C	
Relative Humidity	RH	5		95	%	
Power Supply Voltage	VCC	-0.5		4	V	
Signal Input Voltage		-0.3		Vcc+0.3	V	
Receiver Damage Threshold		5			dBm	

III. Recommended Operating Conditions

Parameter	Symbol	Min.	Typ.	Max.	Unit	Note
Case Operating Temperature	Tcase	0		70	°C	HTSFB-3512-20BD
		-10		80		FYSFB335F(53D)-20BD
		-40		85		FYSFB335F(53D)-20BD
Power Supply Voltage	VCC	3.13	3.3	3.47	V	
Power Supply Current	ICC			280	mA	
Power Supply Noise Rejection				100	mVp-p	100Hz to 1MHz
Data Rate			1.25/1.25		Gbps	TX Rate/RX Rate
Transmission Distance				20	KM	
Coupled Fiber		Single mode fiber				9/125um SMF

IV. Specification of Transmitter

Parameter	Symbol	Min.	Typ.	Max.	Unit	Note	
Average Output Power	P _{OUT}	-9		-3	dBm	Note (1)	
Extinction Ratio	ER	9			dB		
Center Wavelength	λ_c	1290	1310	1330	nm	FYSFB335F-20BD	
		1530	1550	1570		FYSFB353)-20BD	
Spectrum Width (RMS)	σ			3.5	nm	FP Laser (TX:1310nm)	
Side Mode Suppression Ratio	SMSR	30			dB	DFB Laser (TX:1550nm)	
Spectrum Bandwidth(-20dB)	σ			1	nm		
Transmitter OFF Output Power	P _{OFF}			-45	dBm		
Differential Line Input Impedance	RIN	90	100	110	Ohm		
Output Eye Mask	Compliant with IEEE802.3 z (class 1 laser safety)						Note (2)

Note (1): Measure at 2⁷-1 NRZ PRBS pattern

Note (2): Transmitter eye mask definition

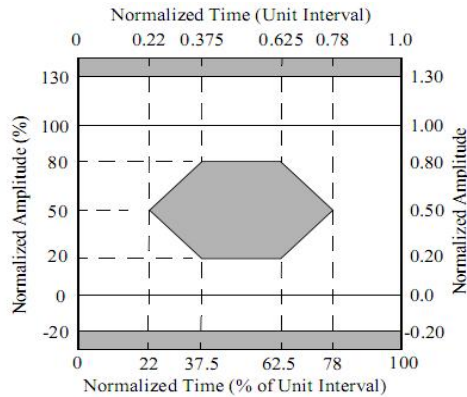

V. Specification of Receiver

Parameter	Symbol	Min.	Typ.	Max.	Unit	Note
Input Optical Wavelength	λ_{IN}	1530	1550	1570	nm	FYSFB335F-20BD
		1290	1310	1330		FYSF353)-20BD
Receiver Sensitivity	P _{IN}			-20	dBm	Note (1)
Input Saturation Power (Overload)	P _{SAT}	-3			dBm	
Los Of Signal Assert	P _A	-35			dBm	
Los Of Signal De-assert	P _D			-22	dBm	Note (2)
LOS Hysteresis	P _A -P _D	0.5	2	6	dB	

Note (1): Measured with Light source 1550nm(1310nm), ER=9dB; BER =<10⁻¹² @PRBS=2⁷-1 NRZ

Note (2): When LOS de-asserted, the RX data+/- output is signal output.

VI. Electrical Interface Characteristics

Parameter	Symbol	Min.	Typ.	Max.	Unit	Note
Transmitter						
Total Supply Current	I _{CC}			A	mA	Note (1)
Transmitter Disable Input-High	V _{DISH}	2		V _{CC} +0.3	V	
Transmitter Disable Input-Low	V _{DISL}	0		0.8	V	
Transmitter Fault Input-High	V _{TxFH}	2		V _{CC} +0.3	V	
Transmitter Fault Input-Low	V _{TxFL}	0		0.8	V	
Receiver						
Total Supply Current	I _{CC}			B	mA	Note (1)
LOSS Output Voltage-High	V _{LOSH}	2		V _{CC} +0.3	V	LVTTTL
LOSS Output Voltage-Low	V _{LOSL}	0		0.8	V	

Note (1): A (TX) + B (RX) = 280mA (Not include termination circuit)

VII. Recommend Circuit Schematic

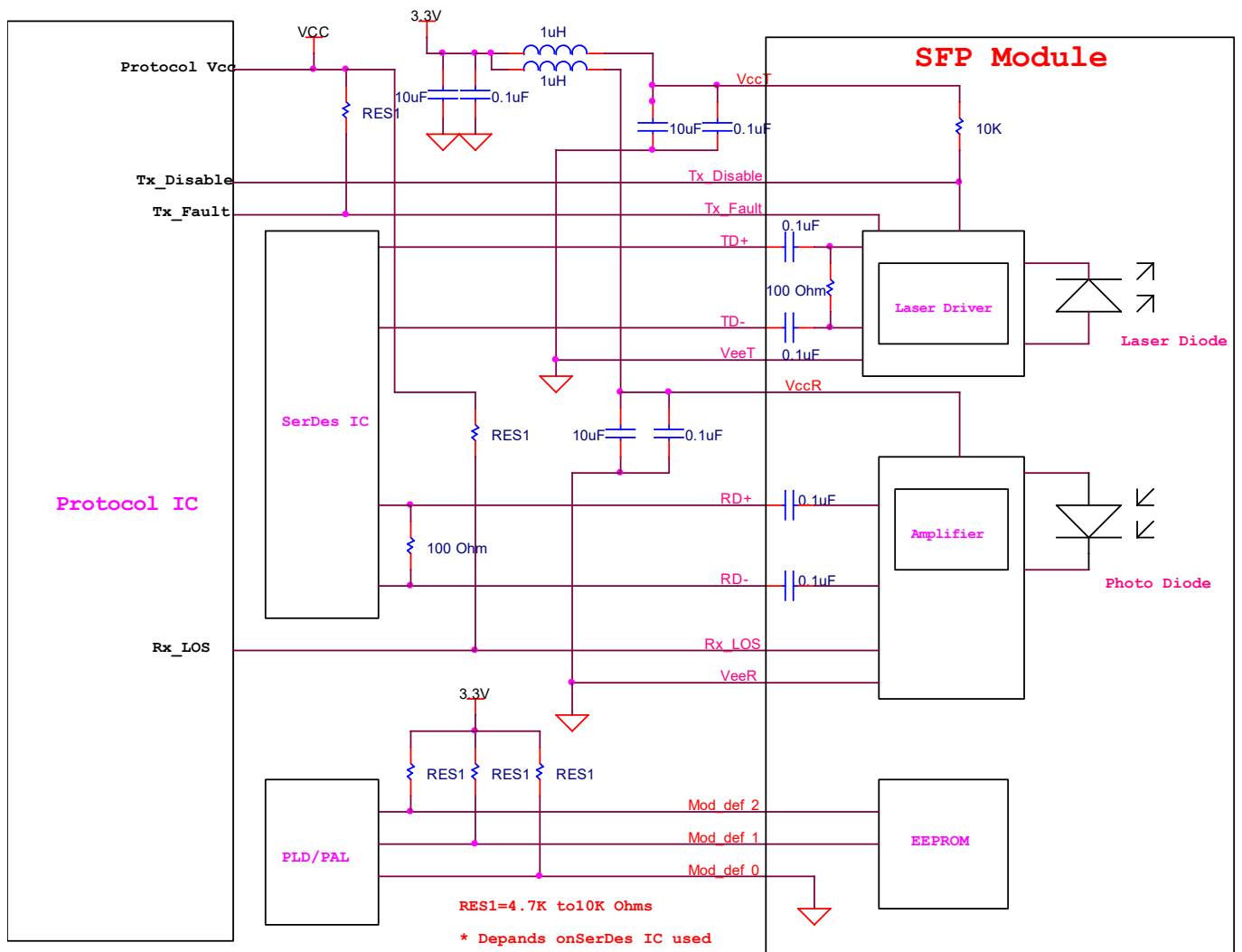

VIII. Mechanical Specifications (Unit: mm)

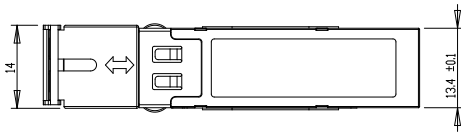

Units in mm

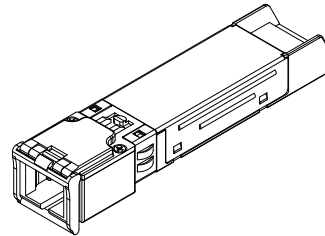
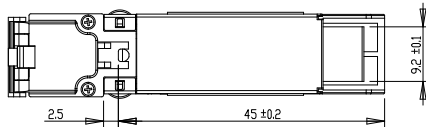
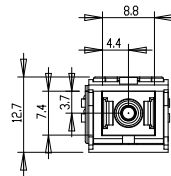
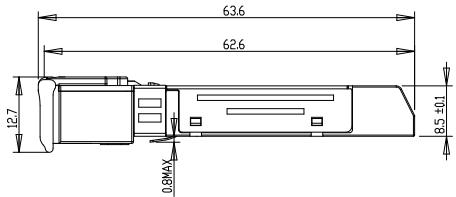

HTSFB-3512-20BD

X Regulatory Compliance

Feature	Reference	Performance
Electrostatic discharge (ESD)	IEC/EN 61000-4-2	Compatible with standards
Electromagnetic Interference (EMI)	FCC Part 15 Class B EN 55022 Class B (CISPR 22A)	Compatible with standards
Laser Eye Safety	FDA 21CFR 1040.10, 1040.11 IEC/EN 60825-1, 2	Class 1 laser product
Component Recognition	IEC/EN 60950 , UL	Compatible with standards
ROHS	2002/95/EC	Compatible with standards
EMC	EN61000-3	Compatible with standards

Appendix A. Document Revision

Version No.	Date	Description
1.0	2020.8.1	Preliminary datasheet